

Kolorowanka

POJAZDY

publicznego transportu zbiorowego
na obszarze MZKZG

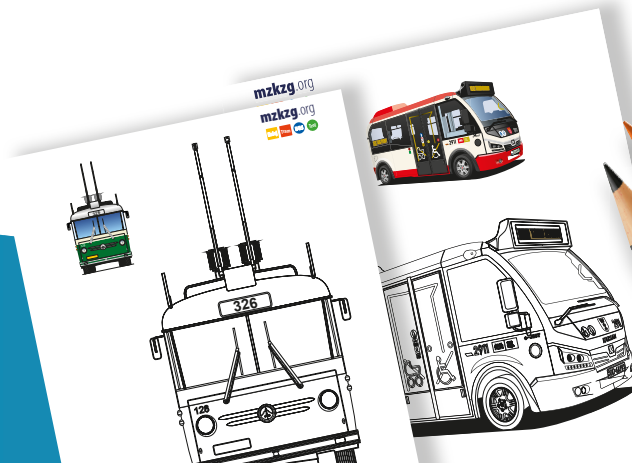

mzkzg.org

wspólny bilet *na komunikację miejską*

ISBN 978-83-970004-0-7



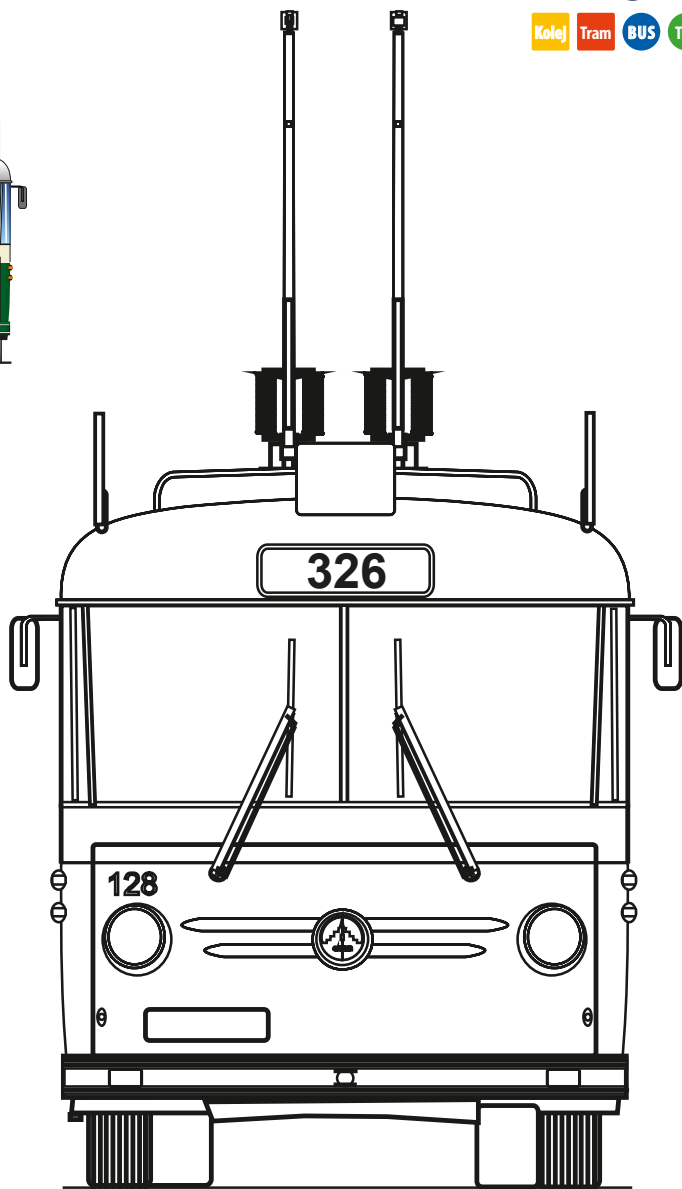
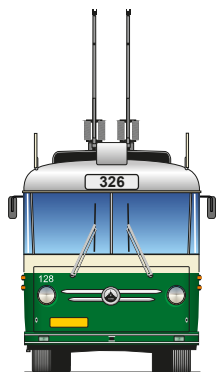

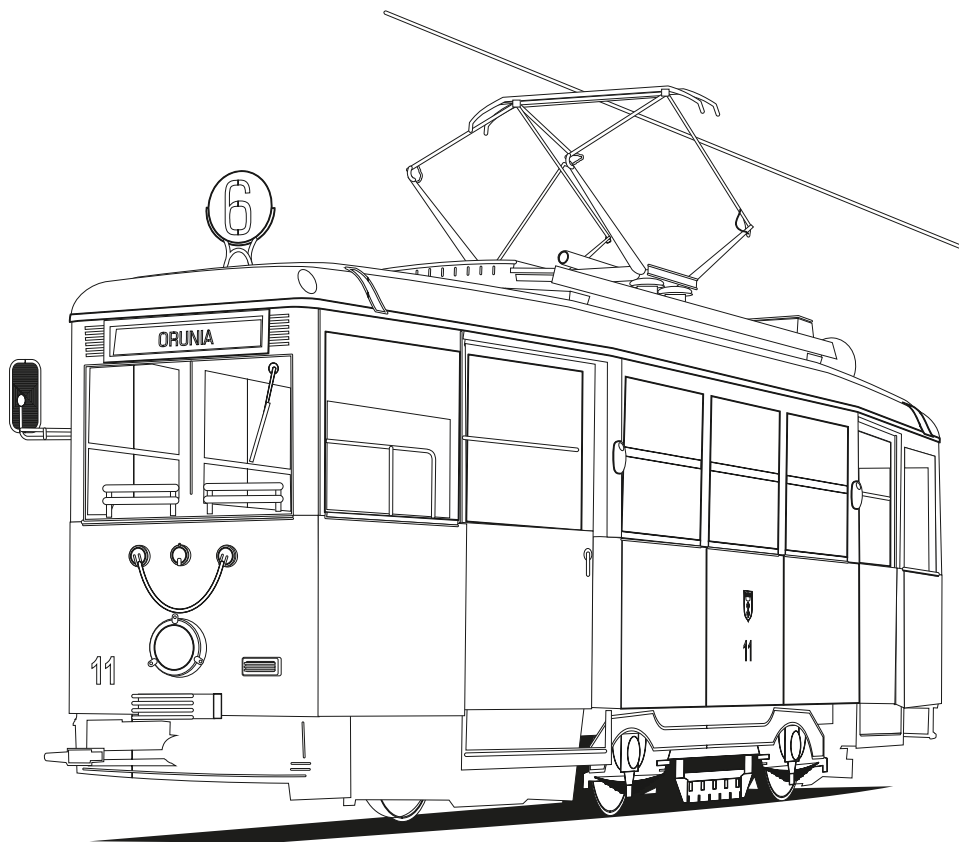

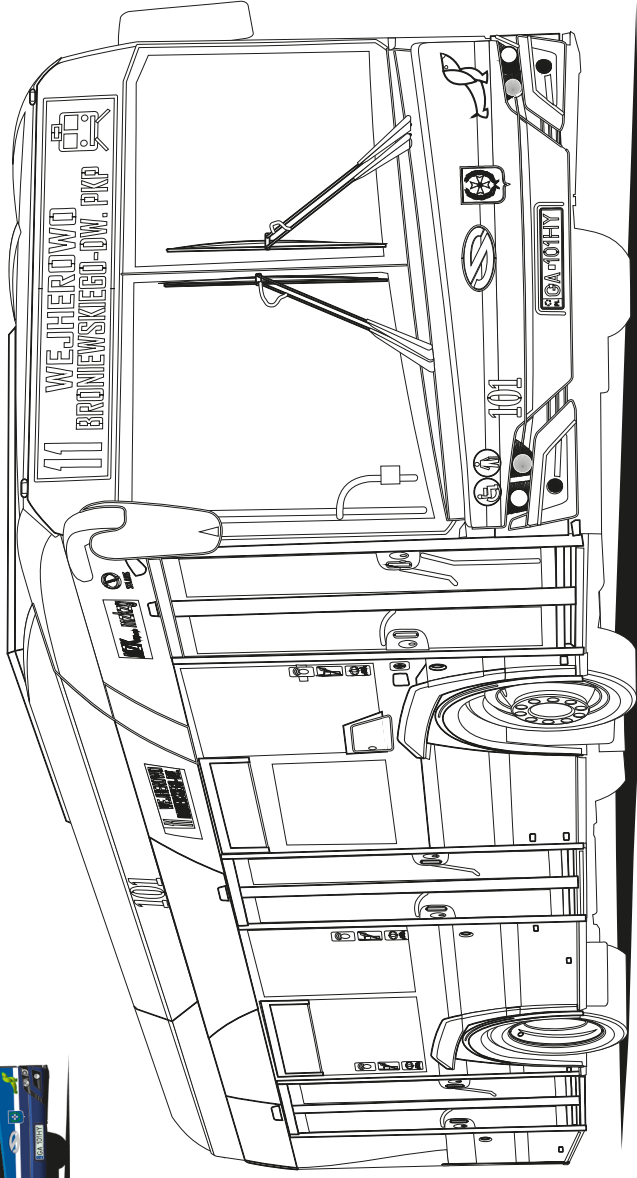

SOLARIS URBINO 12 electric

mzkzq.org

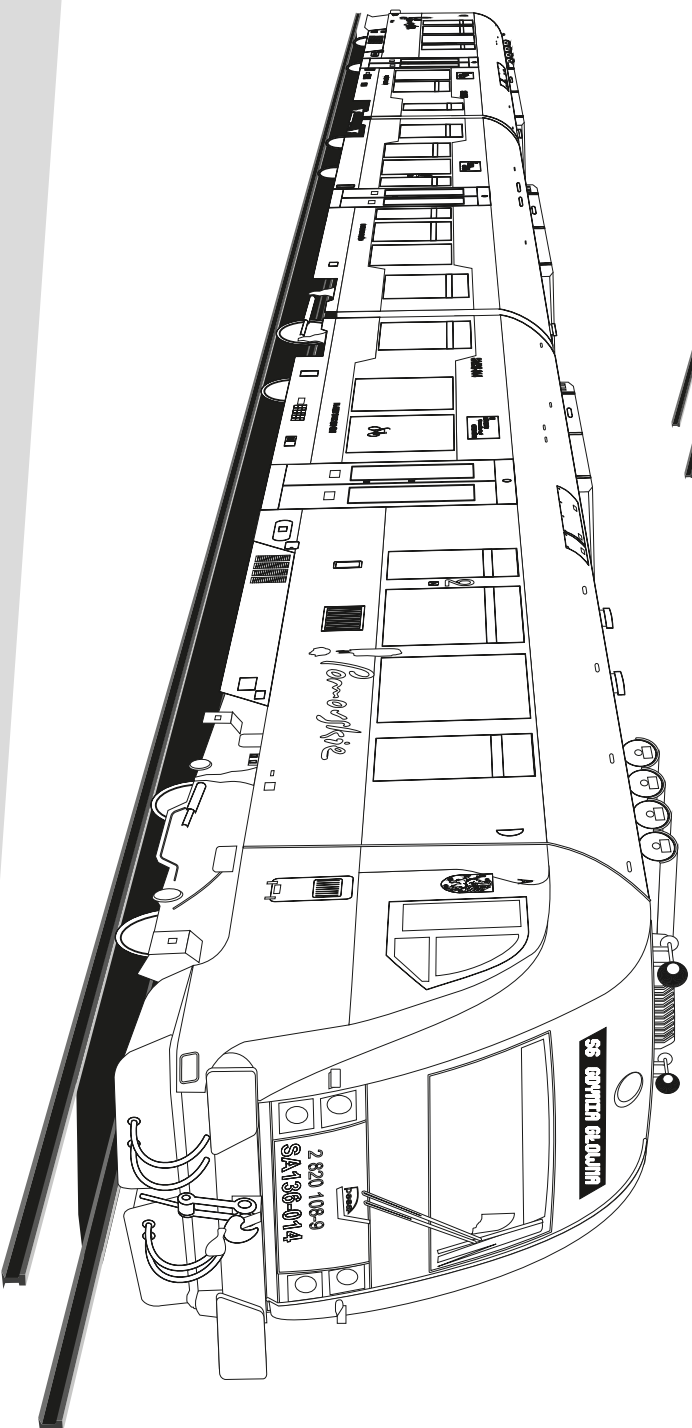
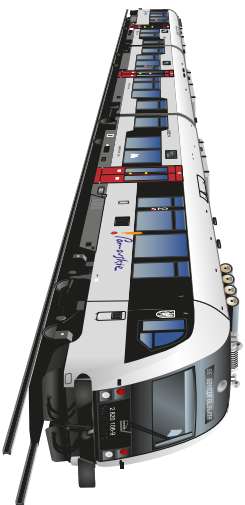

PESA SA136

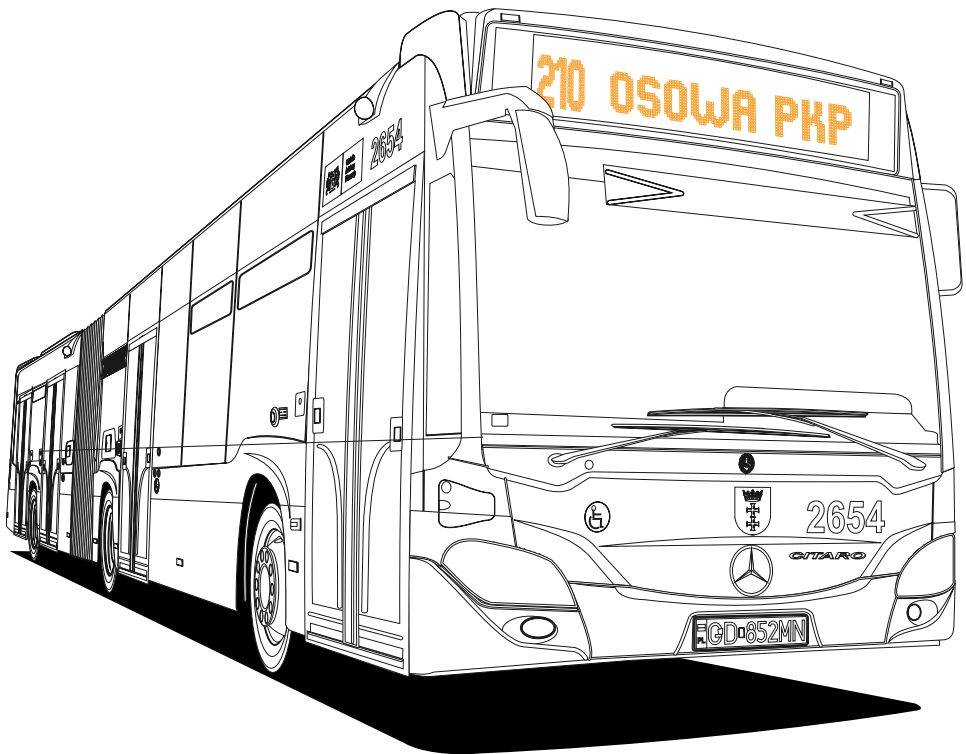

mzkzg.org

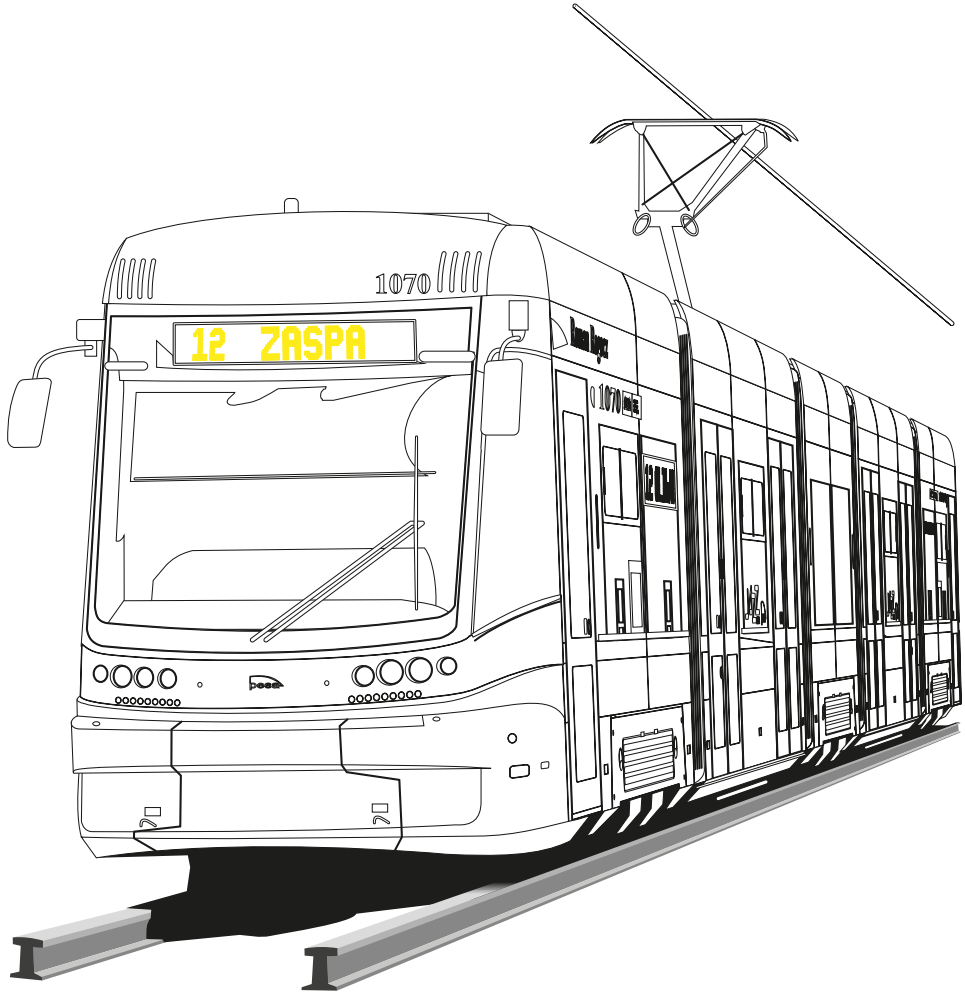

PESA 128 NG JAZZ DUO

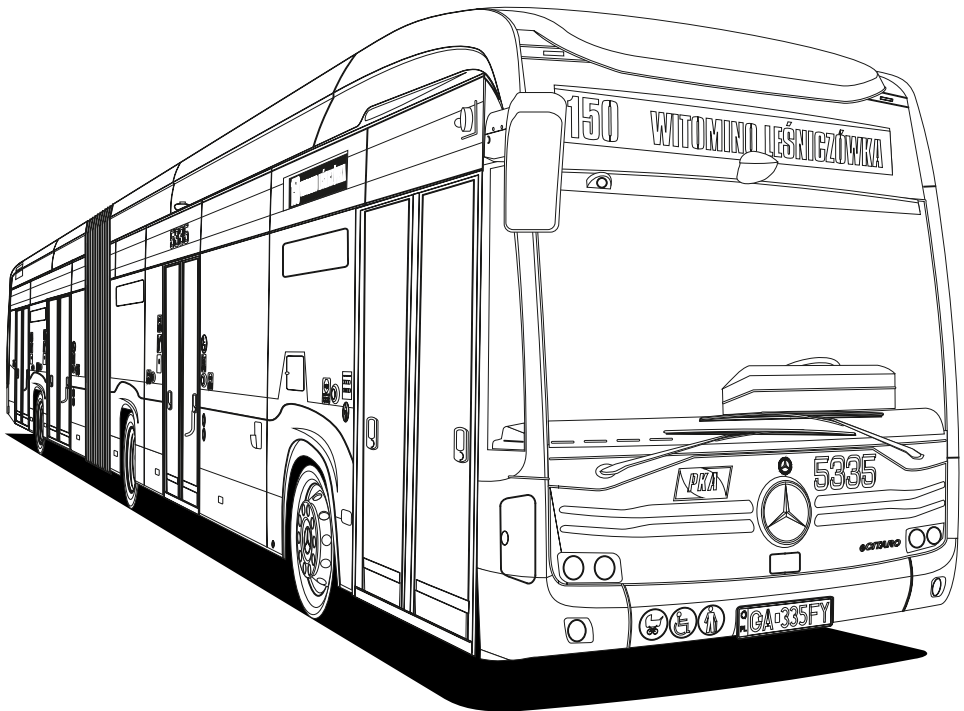

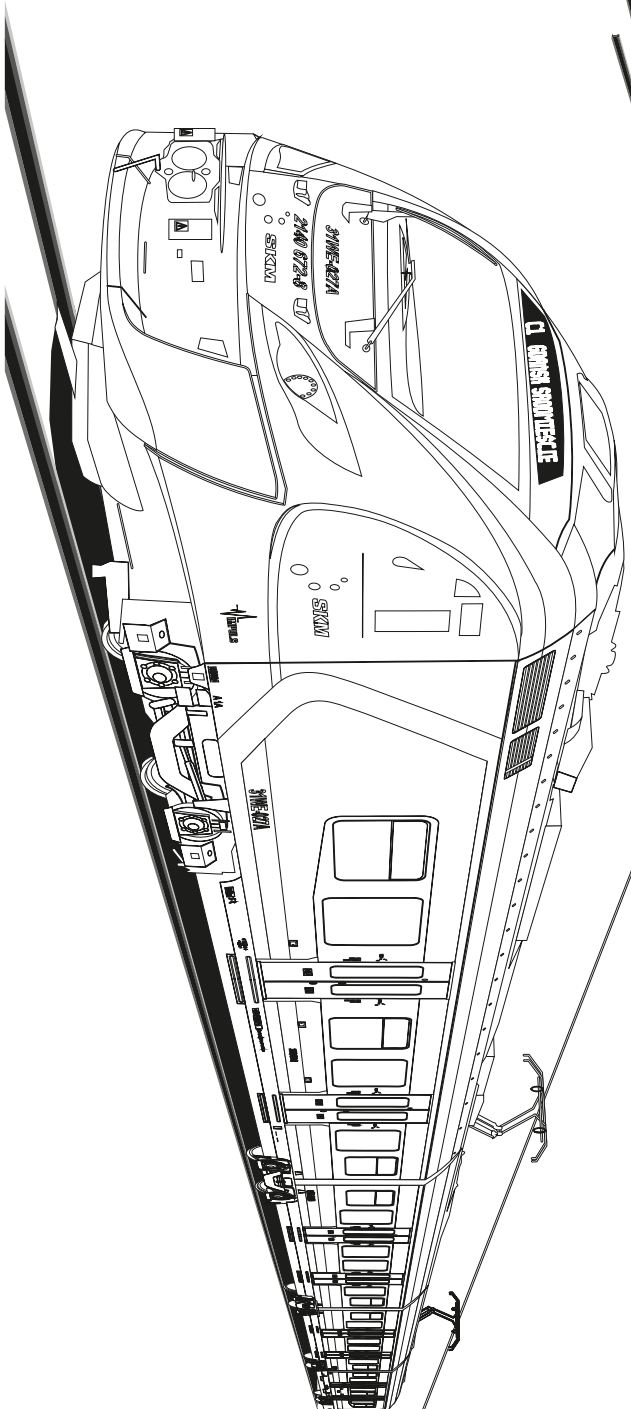

NEWAG IMPULS 31WE

mzkg.org





mzkg.org

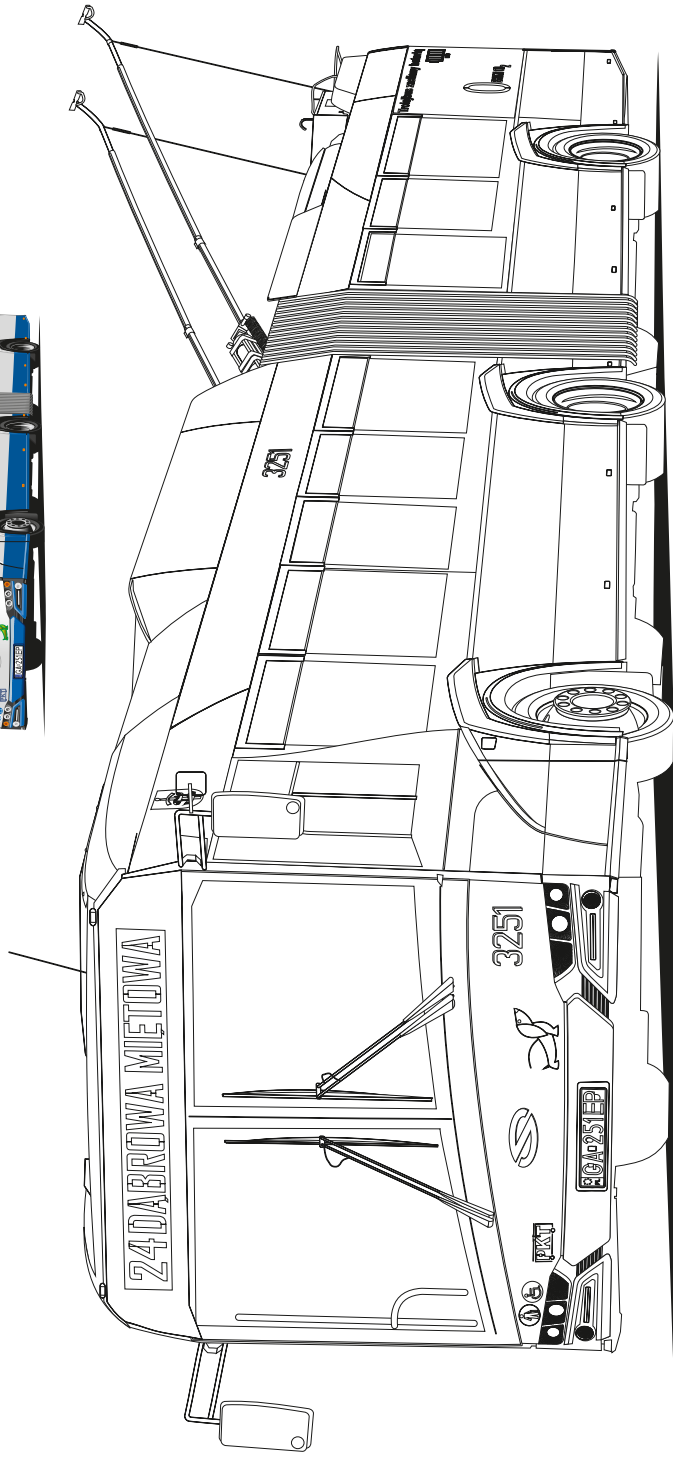

SOLARIS TROLLINO 18M ePN

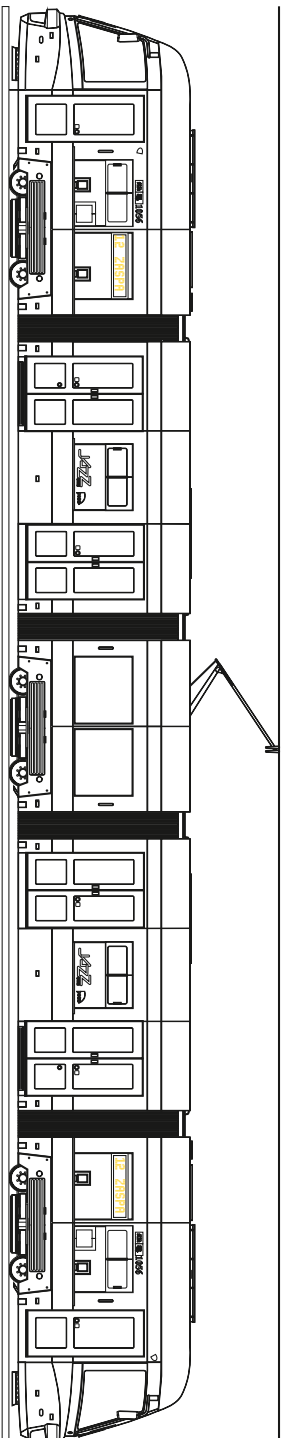
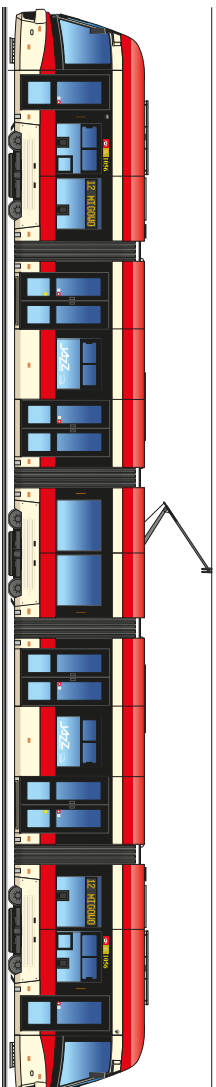

PESA 128 NG JAZZ DUO

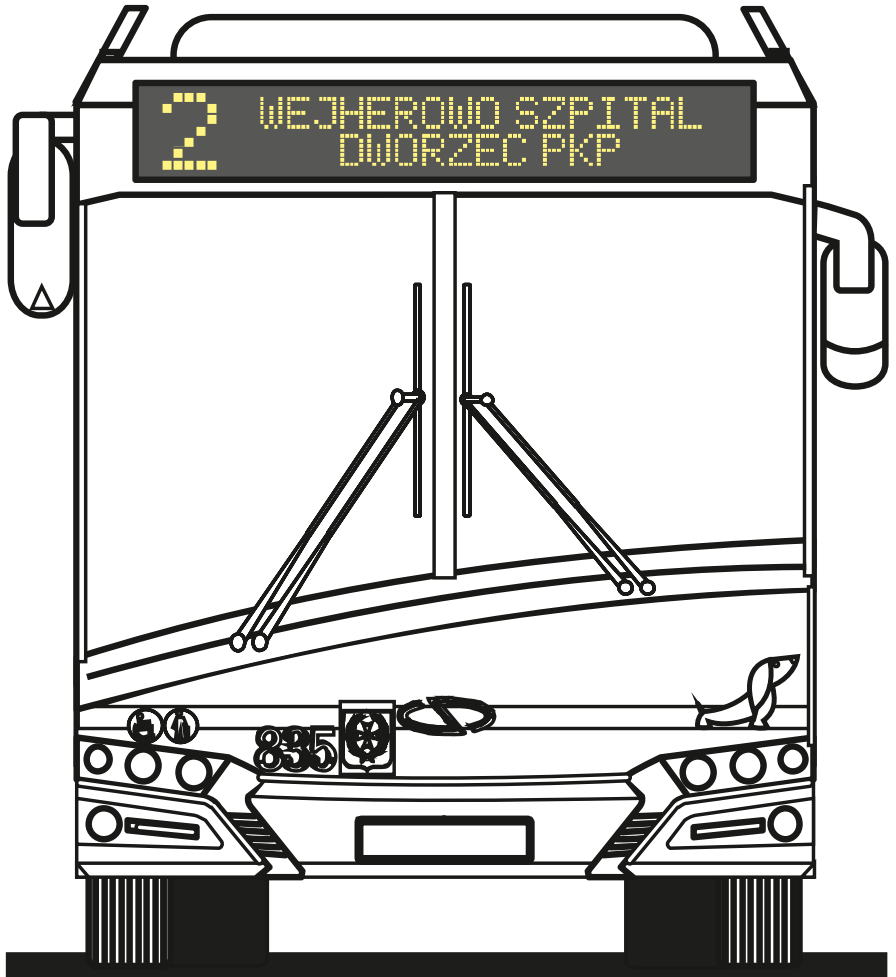

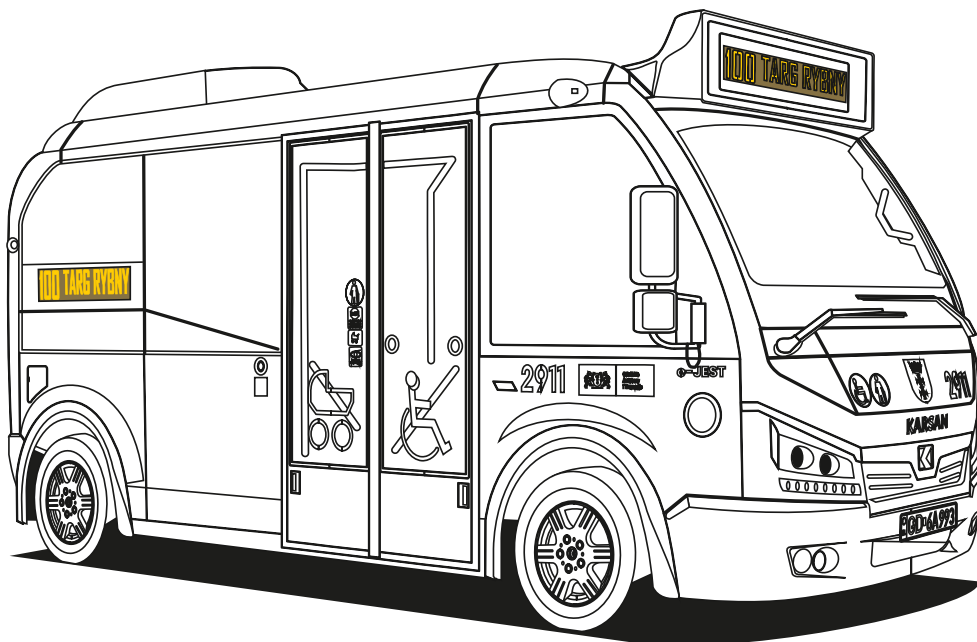
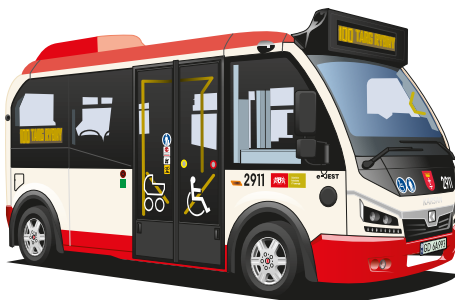

Miasta i gminy tworzące
Metropolitalny Związek Komunikacyjny
Zatoki Gdańskiej



Miasto Gdańsk



Miasto Gdynia



Gmina Kolbudy



Gmina Kosakowo



Gmina Luzino



Gmina Pruszcz Gdański



Miasto Pruszcz Gdański



Miasto Reda



Miasto Rumia



Miasto Sopot



Gmina Szemud



Gmina Wejherowo



Miasto Wejherowo



Gmina Żukowo



mzkzg.org



ISBN 978-83-970004-0-7



METROPOLITALNY ZWIĄZEK KOMUNIKACYJNY
Z A T O K I G D A Ń S K I E J

80-247 Gdańsk, ul. Sobótki 9. Internet: www.mzkzg.org, e-mail: sekretariat@mzkzg.org
NIP: 957-097-61-68 REGON: 220453903 FAX +48 58 342 24 99 TEL. +48 58 342 25 00

